USER'S MANUAL

Barcode Printer

LP 46 NEO



Safety Instructions

Before installing and using the printer, please read the following items carefully.

1. Safety warning



The print head is a thermal element and it is at a high temperature during printing or just after operation, therefore do not touch it or its peripherals for safety's sake.



The print head is an ESD-sensitive device. To prevent damage, do not touch either its printing parts or connecting parts.

2. Notices

- 1) Install the printer on a flat and stable surface;
- 2) Reserve adequate space around the printer so that convenient operation and maintenance can be performed;
- 3) Keep the printer far away from water source, and do not expose the printer to direct sunlight, strong light and heat;
- 4) Do not use or store the printer in a place exposed to high temperature, high humidity or serious pollution;
- 5) Do not place the printer in a place exposed to vibration or impact;
- 6) No condensation is allowed to the printer. In case of such condensation, do not turn on the power until it has completely gone away;
- 7) Connect the printer power to an appropriate grounding outlet. Avoid sharing one electrical outlet with large power motors or other devices that may cause the fluctuation of voltage;

- 8) Disconnect the power when the printer is deemed to idle for a long time;
- 9) Don't spill water or other electric materials into the printer (e.g. metal). In case this happens, turn off the power immediately;
- 10) Do not allow the printer to start printing when there is no recording paper installed; otherwise the print head and platen roller will be damaged;
- 11) To ensure quality print and normal lifetime, use recommended paper or its equivalent;
- 12) Shut down the printer when connecting or disconnecting interfaces to avoid damages to control board;
- 13) Set the print darkness to a lower grade as long as the print quality is acceptable. This will help to keep the print head durable;
- 14) Avoid turning on and off the printer frequently. It is advised to turn on the printer at least 2 seconds after the printer is turned off;
- 15) Do not disassemble the printer without permission of a technician, even for repairing purpose;
- 16) Keep this manual safe and at hand for reference purpose.

Contents

1 PRODUCT DESCRIPTION.....	- 1 -
1.1 INTRODUCTION.....	- 1 -
1.2 UNPACKING AND CHECKING	- 2 -
1.3 APPEARANCE AND MODULE	- 3 -
1.4 INTRODUCTION OF MAIN MODULES	- 4 -
2 PRINTER INSTALLATION.....	- 5 -
2.1 INSTALLATION POSITION	- 5 -
2.2 PAPER ROLL INSTALLATION.....	- 5 -
2.3 RIBBON INSTALLATION	- 7 -
2.4 POWER ADAPTER CONNECTION	- 10 -
2.5 COMMUNICATION CABLE CONNECTION	- 10 -
2.6 START THE PRINTER.....	- 11 -
2.6.1 Power-on and self-test.....	- 11 -
2.6.2 Mark calibration.....	- 11 -
2.6.3 Printing self-test page	- 12 -
2.7 DRIVER SETUP	- 13 -
3 PRINTER OPERATIONS.....	- 16 -
3.1 LED, BUTTON AND BUZZER EXPLANATION	- 16 -
3.1.1 LED functions.....	- 16 -
3.1.2 Button functions	- 16 -

3.1.3 Buzzer functions	- 17 -
3.2 PRINTER STATUS AND OPERATION	- 18 -
3.2.1 Printer status	- 18 -
3.2.2 Daily operations	- 18 -
3.3 SENSOR POSITION ADJUSTMENT	- 19 -
3.4 PRINT POSITION ADJUSTMENT.....	- 20 -
4 ROUTINE MAINTENANCE.....	- 23 -
4.1 CLEANING PRINT HEAD	- 23 -
4.2 CLEANING PLATEN ROLLER.....	- 24 -
5 TROUBLESHOOTING	- 25 -
5.1 TROUBLESHOOTING	- 25 -
5.2 PRINT QUALITY PROBLEMS.....	- 27 -
APPENDIX	- 28 -
APPENDIX 1 TECHNICAL SPECIFICATION.....	- 28 -
Appendix 1.1 Main technical specifications	- 28 -
Appendix 1.2 Technical specifications of paper	- 31 -
APPENDIX 2 SELF-TEST PAGE.....	- 33 -
APPENDIX 3 PRINT AND PAPER OUT POSITION	- 35 -
APPENDIX 4 COMMUNICATION INTERFACE.....	- 36 -
Appendix 4.1 Serial interface	- 36 -
Appendix 4.2 USB interface.....	- 37 -

1 Product description

1.1 Introduction

BTP-U100t label printer is an ideal label and barcode printing device for office use, with delicate appearance and excellent performance. It can apply to many fields, such as medical treatment, retailing, manufacture, logistics, asset management and so on.

BTP-U100t label printer can be connected to the peripherals via serial interface or USB interfaces and can provide universal drivers under the operating systems such as Windows 2000/Windows XP/Windows server 2003/ Windows Vista/ Windows server 2008/ Windows 7/ Windows 8.

Main features:

- Thermal/thermal transfer printing;
- Low noise, high speed printing;
- Modular and open ribbon module, easy paper loading operation and maintenance;
- With 32 bit high speed microprocessor;
- Adopt heat history and auto temperature adaptation control;
- Adopt a new type of print head with long lifetime and high printing quality;
- Support continuous paper, label paper, marked paper, etc;
- Mobile sensor with reflective and transmission sensor together, adaptive for several kinds of paper.

1.2 Unpacking and checking

Unpacking the printer carton and refer to the packing list to check whether the parts are missing or damaged. If there is, please contact with SNBC or your local distributor (communication cables are optional depending on the printer interface type).

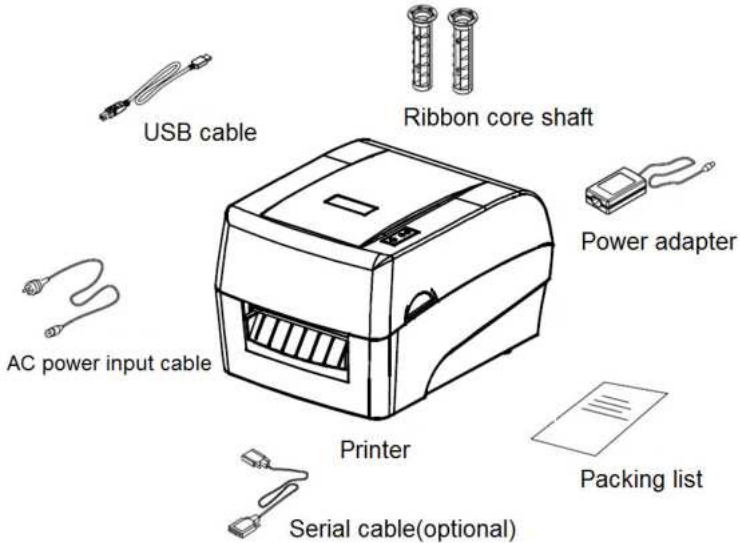
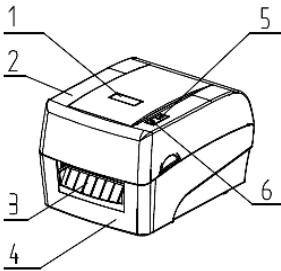
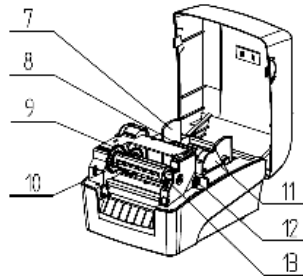

Figure 1.2.1

1.3 Appearance and module



- 1—LOGO plate
- 3—Front baffle plate
- 5—LED
- 7—Paper guide plate
- 9—Ribbon thumb wheel
- 11—Paper cabinet
- 13—Open spanner



- 2—Top cover
- 4—Bottom cover
- 6—Button
- 8—Paper roll holder
- 10—Ribbon holder
- 12—Ribbon end cap

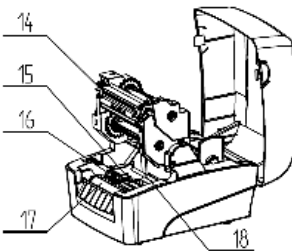

- 14—Print head
- 16—Sensor holder
- 18—Buffer shaft
- 20—USB interface
- 22—Power switch

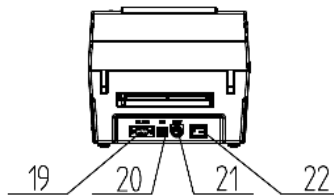

- 15—Paper guide block
- 17—Platen roller
- 19—Serial interface (optional)
- 21—Power interface

1.4 Introduction of main modules

- 1) Button (6) and LED (5): indicate the printer status and complete printing function;
- 2) Paper roll supporting pole (8) and paper guide plate (7): support the paper roll to avoid left and right shaking of paper roll;
- 3) Paper guide block (15): avoid left or right shaking of paper in the paper out path;
- 4) Power switch (22): press “O” to power off and press “—” to power on.
- 5) Sensor is installed inside the sensor holder (16) to realize the paper calibration, detection and positioning.

2 Printer installation

2.1 Installation position

Flatly place the printer on the operation table, which must be waterproof, moisture proof and dustproof. The maximal tilted angle should not exceed $\pm 15^\circ$ during installation.

2.2 Paper roll installation

- 1) Hold the cover open lever with both hands to turn the top cover upwards, and open the top cover of printer (see figure 2.2.1); (see figure 2.2.1);

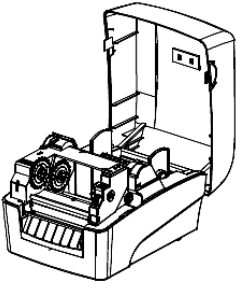

Figure 2.2.1

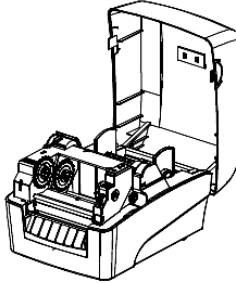

Figure 2.2.2

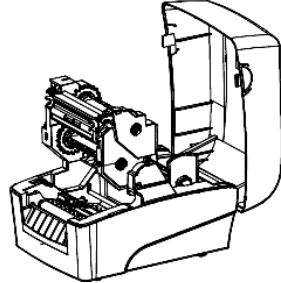
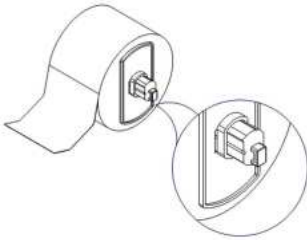
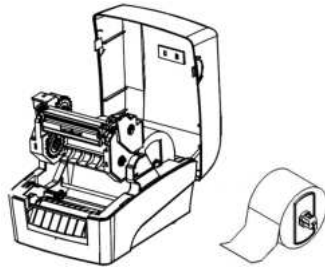

Figure 2.2.3

- 2) Press the cover open lever in the direction of arrow (see figure 2.2.2). After the ribbon holder is uplifted, turn it upwards to the angle as shown in the figure (see figure 2.2.3);
- 3) Install the paper roll onto the paper roll holder, and add one paper guide on each side of the paper roll (see figure 2.2.4);

**Figure 2.2.4****Figure 2.2.5**

- 4) Place the paper roll on the holder into the paper cabinet, pull out the front end of paper and spread it in the print path, and then lead the paper go through under the buffer shaft and finally clamp the paper pulled out with the left and right paper guides (see figure 2.2.5).

**Caution:**

- While opening the top cover, avoid pressing it with force, and open the top cover with force towards upwards;
- The print side of paper should face upwards. If it is marked paper, please make the black mark face downwards;
- The front end of paper should be located in the middle of platen roller as possible as it can.

2.3 Ribbon installation

1) The carbon ribbon shaft has two inner diameters: 12.7mm (1/2 inch) and 25.4mm (1 inch). When the inner diameters of the ribbon shafts are different, the methods for loading ribbon are different:

- A) For the ribbon shaft with an inner diameter 12.7mm (1/2 inch), the operation method is as shown in Figure 2.3.1 (please pay attention to the installation direction). Firstly, rotate the ribbon holder to the position shown in Fig.1, then insert the ribbon into the ribbon end cap in the direction shown in Fig.2 and insert the other end of ribbon into the ribbon thumb wheel, and then pull the ribbon outward slightly until you feel an elastic retraction force which indicates that the installation of ribbon on releasing shaft is complete (see Figure 2.3.1);

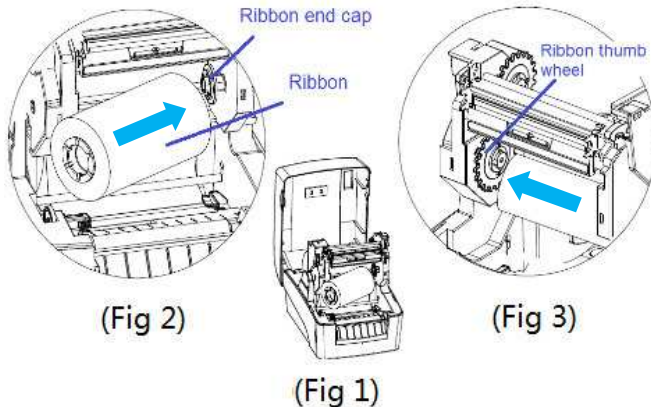

Figure 2.3.1

- B) For the ribbon shaft with an inner diameter 25.4mm (1

inch), insert the ribbon core shaft into the ribbon and the empty ribbon shaft separately (see Figure 2.3.2). And the following operation is the same as in the step A).

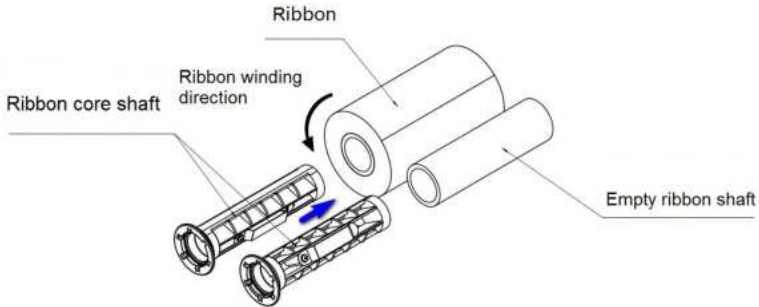

Figure 2.3.2

Rotate the ribbon holder to the position shown in Fig. 1, then insert the assembled ribbon module into the ribbon end cap in the direction shown in Figure 2 and insert the other end of ribbon into the ribbon thumb wheel, and then pull the ribbon outward slightly until you feel an elastic retraction force which indicates that the installation of ribbon on releasing shaft is complete (see Figure 2.3.3);

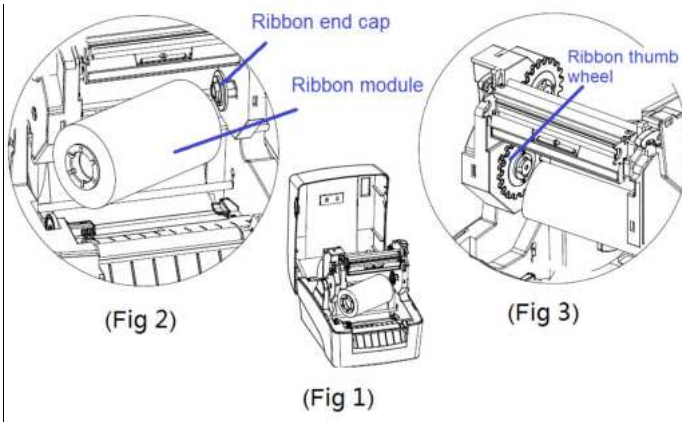

Figure 2.3.3

- 2) Lead the front end of ribbon go through under the print head module and wind it around the rewinding shaft of ribbon;
- 3) Install the rewinding shaft of ribbon onto the ribbon holder according to the method in step 1);
- 4) Push the ribbon thumb wheel to tighten the ribbon (installed paper roll and ribbon refer to figure 2.3.2);

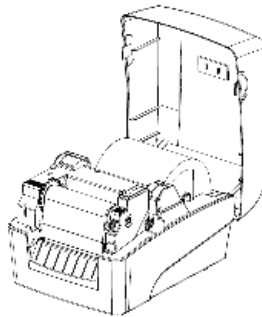

Figure 2.3.2

Figure 2.3.3

- 5) Press down the ribbon holder to locking status, then close the

top cover of printer (see figure 2.3.3).



Caution:

- Make sure the print method:
If selecting thermal transfer printing, the ribbon needs to be installed;
If selecting thermal printing, there is no need to install ribbon.
- Under normal condition, the width of ribbon selected should be wider than that of print medium;
- During the process of installing the ribbon, avoid the wrinkle or damage of ribbon.

2.4 Power adapter connection

- 1) Ensure the printer is turned off;
- 2) Connect one end of the AC power input cable to power adapter, and then insert the other end of the power adapter into the power adapter interface on the back of printer;
- 3) Insert the other end of AC power input cable into the 220V power socket.



Caution:

- If leaving the printer idle for a long time, please disconnect the power of printer.

2.5 Communication cable connection

- 1) Ensure the printer is turned off;
- 2) Insert the communication cable into the suitable interface, and fix it with screw or latch spring of the plug;
- 3) Connect the other end of the communication cable to the host.



Caution:

- Don't connect or disconnect the serial/parallel communication

cable when the power has not been turned off.

2.6 Start the printer

2.6.1 Power-on and self-test

- 1) Ensure the power adapter and the communication cable are connected correctly, and turn on the printer;
- 2) The printer starts the self-test. The buzzer beeps once for a short time after the self-test is finished, and then the LED displays green and it is always on;
- 3) If power-on action is set, the printer will perform power-on action.

Note: Power-on action refers to the actions performed automatically after the printer is turned on, including feeding one label, starting calibration automatically (only valid under discontinuous paper mode). The power-on action can be set by commands or configuration tools.



Caution:

- If the printer can not be started or can not work normally after it is started, please contact SNBC or local dealer in time.

2.6.2 Mark calibration

- 1) Firstly, install the print medium correctly, and then turn on the printer;
- 2) After the printer finishes the self-test, it will enter standby mode. Keep pressing the button and release it after the power LED has flashed two times. Then the printer will start feeding paper and start calibration;

- 3) If the calibration is successful, the printer will enter standby mode; If the calibration fails, the printer will alarm. Then please make sure whether the installation of medium is correct.

If any of the following cases occurs, please calibrate the medium before the printing:

- The first time to install and operate the printer or the first time to use the printer after the sensor has been cleaned;
- Use the printer again after the printer has been idled for a long time or replace new kinds of paper roll;
- Cannot identify the marks effectively during the process of printing;
- The using environment of printer has changed greatly.



Caution:

- After the above steps and after having cleaned the sensor, if still cannot find out the reason of calibration failure, please contact with maintenance personnel.

2.6.3 Printing self-test page

- 1) Install the media, and turn on the printer. Keep pressing the button and release it after the LED has flashed one time, then the printer will feed paper and print self-test page (see [Appendix 2.1](#));
- 2) The self-test page lists the current configuration information of the printer.

2.7 Driver setup

The installation program of the driver can be downloaded from the website www.snbc.cn.

- The 32-bit operating systems supported by the driver are as follows:

Windows 2000/Windows XP/Windows server 2003/Windows Vista/Windows server 2008/Windows 7/Windows 8/Windows 10.

- The 64-bit operating systems supported by the driver are as follows:

Windows XP/Windows server 2003/Windows Vista/Windows server 2008/Windows 7/Windows 8/Windows 10.

- 1) Run "Setup.exe" in the driver package, and read the related software license agreement carefully. If you accept the items in the license agreement, please click "I accept the items in the software license agreement", and then click "Next" button;



- 2) Select printer type and model to be installed. If you want to set the printer as default printer, please select "Set As Default Printer" and click "Next";

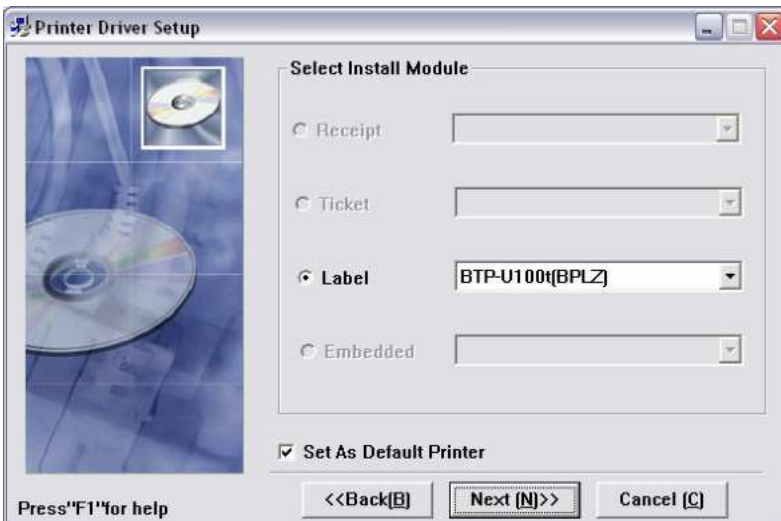

- 3) Select setup type, and click "Next";
- 4) The driver will select the current OS type automatically, and click "Next" button;
- 5) Set printer port. User can select it according to actual needs. If it is a serial port driver, please select "COMx" (x equals to 1, 2, 3, 4, 5, 6, 7 or 8); if it is USB port, please select "USB00x" (x equals to 1, 2, 3, 4, 5, 6, 7 or 8), (if USB port printer is connected correctly to the computer under power-on status, the driver setup program will set USB port as default port automatically). Then click "Install" to end the installation.

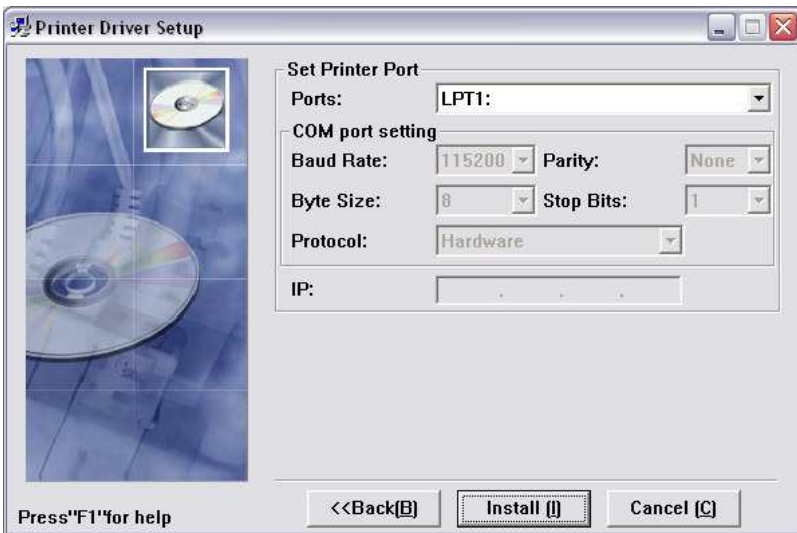

3 Printer operations

3.1 LED, button and buzzer explanation

3.1.1 LED functions

LED name	Status	Explanation
Work LED (green)	Always on	Printer is idle or working.
	Flash	Printer is busy.
Pause LED (green+red)	Always on	Printer is in pause status.
	Flash	Printer is in updating status.
Error LED (red)	Flash	An error occurs. See 5.1 Troubleshooting for details.

3.1.2 Button functions

Button	Function	Explanation
Short press	Feed paper	In standby status, press the button for a short time to feed paper.
	Pause	During the printing, press the button for a short time to enter pause status.
	Continue	After the printer enters pause status, press the button for a short time to resume the printing.
Long press	Self-test page	Keep pressing the button for a long time and release it after the green LED has flashed one time.
	Calibration	Keep pressing the button for a long time and release it after the green LED has flashed

		two times.
	Restore default configuration of serial interface	Keep pressing the button for a long time and release it after the green LED has flashed three times.
	Print waveform of sensor	Keep pressing the button for a long time and release it after the green LED has flashed four times.
	Restore factory setting	Keep pressing the button for a long time and release it after the green LED has flashed five times.

Note: Short press means the duration from pressing down the button to the time when the button uplifts is less than 0.5s.

Long press means the duration of pressing down the button is more than 1s.

3.1.3 Buzzer functions

- 1) The buzzer beeps for a short time when the printer is turned on or resets;
- 2) The buzzer beeps many times when an exception occurs. For the details, please refer to [5.1 Troubleshooting](#).

3.2 Printer status and operation

3.2.1 Printer status

The printer has four statuses: idle status, working status, pause status, and abnormal status.

Printer status	LED
Idle status	Green LED is always on and red LED is always off.
Working status	Green LED is always on and red LED is always off.
Pause status	Green LED and red LED are always on.
Abnormal status	Refer to 5.1 Troubleshooting .

Note: The work LED flashes twice when pressing the button for a long time under any of the status listed above.

3.2.2 Daily operations

➤ Operations under idle status

It refers to the ready status when the printer is normal and waiting for an operation or a task. The printer enters idle status by default after turning on normally or returns to idle status after finishing performing a task. Under idle status, if pressing the button for a short time, the printer will feed paper; if pressing the button a long time and releasing the button after the green LED flashes, the printer will select the corresponding functions.

➤ Operations under working status

It refers to the status when the printer has a printing task. The

printer will enter pause status if releasing the button after pressing it down at this time.

➤ Operations under pause status

The printer is under the status of stopping the printing task temporarily. The printer will enter pause status under the following situations:

- 1) Press down the button during normal printing;
- 2) After an exception is removed.

When the printer is in pause status, press the button for a short time to resume the print task.

➤ Operations under abnormal status

It refers to the status when an exception occurs. The printer failure is prompted by LED and buzzer. For the details of failure prompting and removing, refer to [5.1 Troubleshooting](#).

3.3 Sensor position adjustment

The sensor is assembled in the sensor holder, and it can move to the left and right sides (see Figure 3.3.1). While loading the medium, firstly adjust the paper guide, and then adjust the sensor holder module. If black mark paper is used, please adjust the arrow on the sensor holder module to be aligned with the black mark on the medium. The specification of the medium used should meet the requirements in Appendix 1.2.

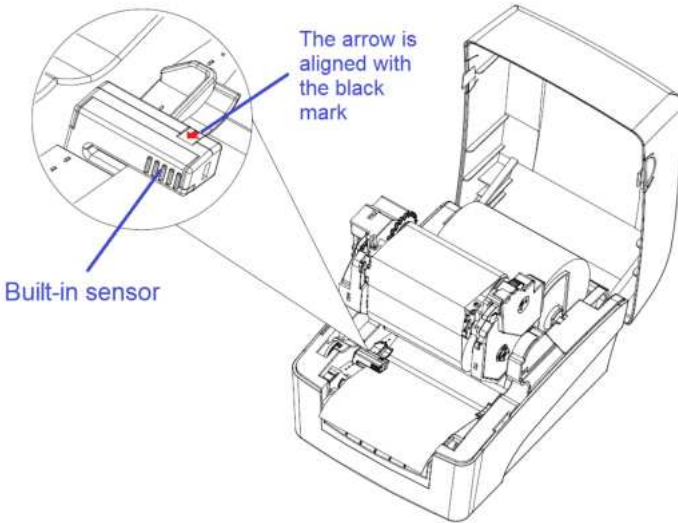

Figure 3.3.1

3.4 Print position adjustment

1) Adjust vertical print position

When the situation like figure A or B occurs, adjust the vertical print position to figure C.

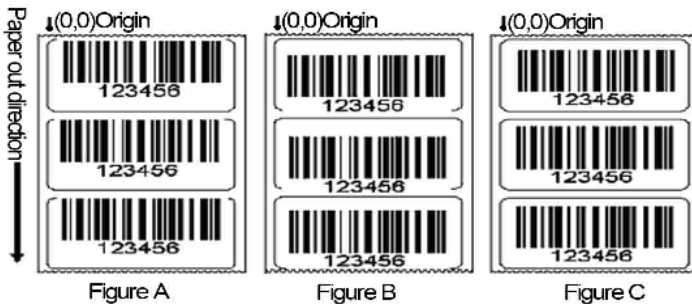

Figure 3.4.1

 **Caution:**

- Figure A indicates that the print position is upper than the correct position. Adjust it in the positive direction (The data symbol in the option “Vertical position adjustment” is “+”);
- Figure B indicates that the print position is lower than the correct position. Adjust it in the negative direction. (The data symbol in the option “Vertical position adjustment” is “-”).

2) **Adjust horizontal print position**

When the situation like figure D or E occurs, adjust the horizontal print position to figure F.

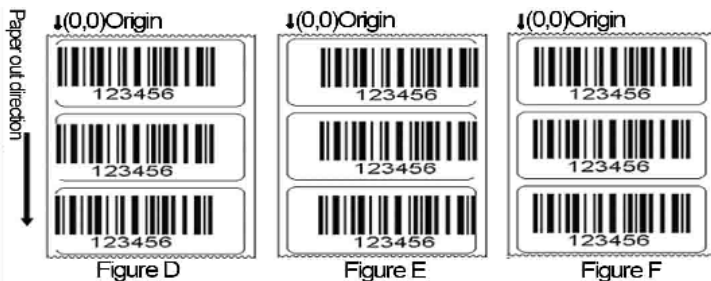

Figure 3.4.2

 **Caution:**

- Figure D indicates that the print position is on the left of the correct position. Adjust it in the positive direction (The data symbol in the option “Horizontal position adjustment” is “+”);
- Figure E indicates that the print position is on the right of the correct position. Adjust it in the negative direction. (The data symbol in the option “Horizontal position adjustment” is “-”).

3) **Adjust tear-off position**

When the situation like figure G or H occurs, adjust the tear-off position to figure J.

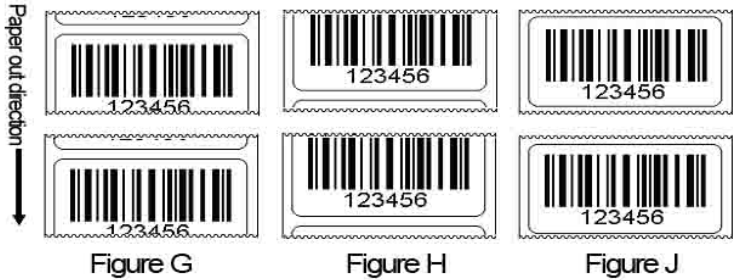

Figure 3.4.3



Caution:

- Figure G indicates that the tear-off position is upper than the correct position. Adjust it in the negative direction; (The data symbol in the option “Tear-off position adjustment” is “-”);
- Figure H indicates that the tear-off position is lower than the correct position. Adjust it in the positive direction. (The data symbol in the option “Tear-off position adjustment” is “+”).

4 Routine maintenance

Clean the print head, platen roller and sensor every month according to the following steps. If the printer works in a tough environment, the maintenance times can be properly increased.

4.1 Cleaning print head

When any of the following cases occurs, the print head should be cleaned:

- Printout is not clear;
- Feed or retract paper with big noise;
- Something else sticks onto the print head.

Follow the steps below to clean the print head:

- 1) Turn off the printer and open the top cover;
- 2) Lift up the top cover and find the print head. Wait for print head to cool down completely if it has just finished the printing;
- 3) Wipe off the dust and stains on the surface of the print head with alcohol cotton ball (it should be wrung out);
- 4) Wait for 5 to 10 minutes until the alcohol evaporates completely, press down the print head module, and close the top cover.

4.2 Cleaning platen roller

When any of the following cases occurs, the platen roller should be cleaned:

- Printout is not clear;
- Feed and retract paper with big noise;
- Something else sticks onto the platen roller.

Follow the steps below to clean the platen roller:

- 1) Turn off the printer and open the top cover;
- 2) Uplift the top cover and find the platen roller. Wait for the platen roller to cool down completely if it has just finished printing;
- 3) Wipe off the dust and stains on the surface of the platen roller with alcohol cotton ball (it should be wrung out) while turning the platen roller;
- 4) Wait for 5 to 10 minutes until the alcohol evaporates completely, and close the top cover.



Caution:

- Before starting routine maintenance of printer, make sure the printer is turned off;
- Do not touch the surface of print head with hands or metal objects. Do not use forceps in case it scratches the surface of the print head, platen roller and sensor;
- Do not use organic solvent like gasoline, acetone etc. to clean the print head or platen roller;
- Please wait for alcohol to evaporate completely before starting printing.

5 Troubleshooting

When the printer has a malfunction, please handle it with reference to this charter. If it still cannot be cleared, please contact SNBC or your local dealer.

5.1 Troubleshooting

The error LED flashes and the buzzer beeps when an error or exceptional status occurs. At this time, the printer stops the printing. Please handle it with reference to the following method:

Error indication mode:

Error message	Buzzer	Error LED
Print head up	2 beeps	Red LED flashes 2 times circularly
Paper end	3 beeps	Red LED flashes 3 times circularly
Out of ribbon	4 beeps	Red LED flashes 4 times circularly
Abnormal temperature of print head	No beep	Red LED flashes 5 times circularly
Cannot find marks	No beep	Red LED flashes 6 times circularly
Mark calibration error	No beep	Red LED flashes 7 times circularly

Troubleshooting methods:

Error LED status	Reason analysis	Solutions
Print head up	Print head is lifted up.	Please press down the print head.
	The micro switch has a failure.	Contact the maintainer.
Paper end	Paper roll is used up or no paper roll is installed.	Install a paper roll.
	Paper jam	Clear the paper jam.
	Paper roll surface is dirty or damaged.	Please skip the dirty or damaged part.
	Paper roll breaks away from the mark sensor.	Install a paper roll again.
	The surface of mark sensor is dirty.	Clean mark sensor surface.
	The position of reflective sensor is not correct.	Adjust the sensor position according to the description in 3.4.
	Paper roll type does not match with mark sensor type.	Set the paper type in printer driver to make it consistent with actual paper type.
Lack of ribbon	Ribbon is used up	Install ribbon
	Ribbon is jammed	Clear up the ribbon
	Ribbon sensor has failures	Replace the ribbon sensor
Print head temperature abnormal	Operating environment temperature is too high, causing overheating print head.	Please improve ventilation condition. The printer can return to normal with the fall of temperature.

	Print darkness is too high.	Lower the print darkness properly.
	Paper is jammed in the path, causing heat accumulation and overheating print head.	Clear paper jam. Check if the print head test pattern is normal or not after the temperature of print head drops. If normal, the printer can continue to work; otherwise please replace the print head.
Mark location failure or mark calibration failure	Paper type does not match with sensor type.	Set the paper type in printer driver to make it consistent with actual paper type.
	Something wrong with marked paper (for example: no mark or unclear mark)	Use the required media.
	Mark height is less than the required height.	

Table 5.1.1

5.2 Print quality problems

Malfunction	Reason	Solution
Printout is unclear or has stains.	Print head or platen roller is dirty.	Clean the print head or platen roller.
	Paper does not meet the requirement.	Use recommended paper.
	Print darkness is too low.	Increase print darkness.
	Paper is not installed correctly.	Install paper roll correctly.

Table 5.2.1

Appendix

Appendix 1 Technical specification

Appendix 1.1 Main technical specifications

	Item	BTP-U100t parameter
Printing	Resolution	203DPI
	Print method	Thermal / Thermal transfer
	Print width (Max.)	104mm
	Print speed (Max.)	150mm/s
	CPU	32bit RISC microprocessor
	Memory	FLASH: 4MB SDRAM: 8MB.
	Print head temperature detection	Thermal resistor
	Print head position detection	Micro switch
	Paper mark detection	Photoelectric sensor
	Paper existence detection	Photoelectric sensor
	Communication interface	Optional interface: standard configured USB interface; RS-232 serial interface is optional.

Media	Paper type	Continuous paper, label paper, marked paper, etc.
	Paper roll OD (Max.)	127mm (5 inches)
	Paper roll width (Max.)	110mm
	Paper roll ID	25mm (1 inch)/38mm (1.5 inch)
	Paper thickness	0.06mm-0.20mm
	Ribbon length (Max.)	300m
	Ribbon ID	12.5mm
	Paper out mode	Tear off
Character Barcode Graphics	Character enlargement/rotation	Support four types of rotation printing (0°, 90°, 180°, 270°) Bitmap fonts can be enlarged up to 10 times. Vector fonts can be zoomed without scale.
	Character set	7 bitmap fonts and 1 vector font are built-in.
		User-defined bitmap and vector fonts can be downloaded into the printer.
Graphics	Plain bitmaps in binary system, HEX, PCX, BMP and IMG files can be downloaded to FLASH or RAM.	

	Barcode	<p>1D barcode: Code39, Code93, Codabar, Code128(Subsets A, B, and C), EAN-13, EAN-8, UPC-A, UPC-E, UPC/EAN Extensions, Planet Code, Standard 2 of 5, Industrial 2 of 5, Interleaved 2 of 5, LOGMARS, GS1 DataBar (RSS)</p> <p>2D barcode: PDF 417, MicroPDF417, QR Code, DataMatrix, MaxiCode, GS1 Composite</p>
Operation interface	Button, LED	1 button, 2 LEDs
Power adapter	Input	AC 100~240V, 50/60Hz
	Output	DC 24V, 2.5A
Environmental requirements	Operating environment	+5°C~45°C, 20%~90%(40°C)
	Storage environment	-40°C~60°C, 20%~93%(40°C)
Physical features	Overall size	278mm (L)×218mm(W)×185mm(H)
	Weight	About 2.3Kg

Table appendix 1.1.1

Appendix 1.2 Technical specifications of paper

1) Specifications of continuous paper (unit: mm)

Type	Illustration	Index
Continuous paper without adhesive	 <p style="text-align: center;">Paper without adhesive</p>	Print paper width: $18 \leq a \leq 120$
Continuous paper with adhesive	 <p style="text-align: center;">Paper with adhesive</p>	Base paper width: $18 \leq a \leq 120$ Print paper width: $18 \leq b \leq 118$ Paper margin width: $c \leq 1$

Table appendix 1.2.1

2) Discontinuous paper specifications (unit: mm)

Type	Illustration	Index
Discontinuous label paper with adhesive		<p>Base paper width: $18 \leq a \leq 120$</p> <p>Paper margin width: $b \leq 1$</p> <p>Label width: $18 \leq c \leq 118$</p> <p>Label height: $d \geq 10$</p> <p>Gap width: $e \geq 2$</p>
Discontinuous punched paper without adhesive		<p>Punched paper width: $18 \leq a \leq 120$</p> <p>Punched paper height: $b \geq 10$</p> <p>Detection hole position: $c \leq a/2$</p> <p>Detection hole width: $d \geq 5$</p> <p>Detection hole height: $e \geq 2$</p>
Discontinuous marked paper without adhesive		<p>Marked paper width: $18 \leq a \leq 120$</p> <p>Marked paper height: $b \geq 10$</p> <p>Mark position: $c \leq a/2$</p> <p>Mark width: $d \geq 10$</p> <p>Mark height: $e \geq 4$</p>

Table appendix 1.2.2

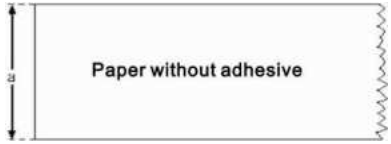
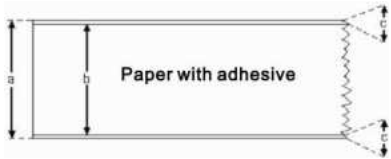
Appendix 2 Self-test page

Self-test page includes printer configuration information, printer internal fonts and print head test information. The printer configuration information and printer internal fonts reflect the current internal configuration of the printer, and the print head test information reflects the status of the print head.

Printer configuration information (BPLZ II) is related to the configuration of the printer.

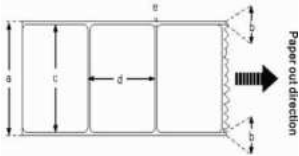
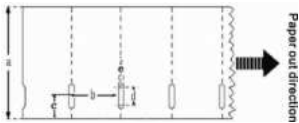
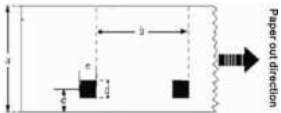
PRINTER CONFIGURATION

BTP-U100t.....	MODEL
FV2.000.....	MAIN FIRMWARE
10.....	DARKNESS
+0.....	TEAR OFF
TEAR OFF.....	PRINT MODE
CONTINUOUS.....	MEDIA TYPE
MEDIA.....	SENSOR TYPE
MANUAL.....	SENSOR SELECT
DIRECT-THERMAL.....	PRINT METHOD
56.....	PRINT WIDTH
640.	LABEL LENGTH
11IN 300MM.....	MAXIMUM LENGTH
CONNECTED.....	USB COMM
NONE.....	PARALLEL COMM
115200.....	BAUD
8 BITS.....	DATA BITS

NONE.....	PARITY
HARD.....	HOST HANDSHAKE
NONE.....	PROTOCOL
<~> 7EH.....	CONTROL CHAR
<^> 5EH.....	COMMAND CHAR
<,> 2CH.....	DELIM. CHAR
NO MOTION.....	MEDIA POWER UP
NO MOTION.....	HEAD CLOSE
DEFAULT.....	BACKFEED
+0.....	LABEL TOP
+0.....	LEFT POSITION
100mm/s.....	PRINT SPEED
100mm/s.....	FEED SPEED
100mm/s.....	BACKFEED SPEED
203DPI.....	RESOLUTION
16360K.....	R: RAM
1472K.....	E: ONBOARD FLASH
NONE.....	FORMAT CONVERT
0123456789.....	SERIAL NUMBER

Appendix 3 Print and paper out position

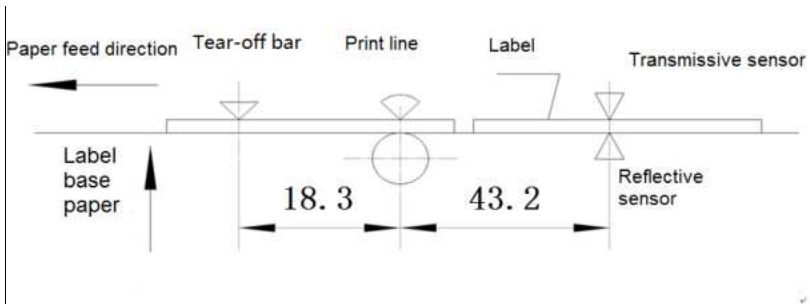

Figure appendix 3.1



Caution:

- To take marked paper for example, the figure above explains the print and paper out position;
- Discontinuous paper locates by the front edge of the mark;
- Refer to 3.4 Print position adjustment.

Appendix 4 Communication interface

Appendix 4.1 Serial interface

1) Interface signal

Pin	Signal name	Signal direction	Function
1	None		
2	RXD	Input	Data input
3	TXD	Output	Data output
4	DTR	Output	Data terminal ready
5	SG	—	Signal ground
6	DSR	Input	Data device ready
7	RTS	Output	Request transmission
8	CTS	Input	Allow transmission
9	FG	—	Frame ground

Table appendix 4.1.1 printer signal and status

2) Wiring diagram

```

PC           Printer
TXD-----RXD
RXD-----TXD
CTS-----RTS
RTS-----CTS
SG -----SG
    
```

 **Caution:**

- The following connection method can be used, which only needs 3 wires. This method applies to small data amount or XON/XOFF flow control:

```

PC           Printer
TXD-----RXD
RXD-----TXD
SG -----SG
    
```

Appendix 4.2 USB interface

USB interface meets USB1.1 protocol standard and is optional.

USB interface transmits signal and power via a four-wire cable, as shown in the following figure:

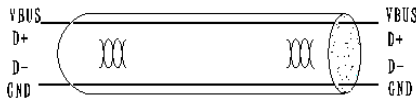

Figure appendix 4.2.1 USB cable

Wire D+ and D- in figure appendix 4.3.1 are used for signal transmission, and the VBUS is +5V.

Annapurna Technologies Inc.

No.48/2, 2nd Floor, 48, Rashtriya Vidyalaya Rd, Basavanagudi, Bengaluru, Karnataka 560004

Sales Inquiries : +91-9945003176 | Technical Support : +91-9945605979

www.annatechinc.com | Email : srinivas@annatechinc.com

Landline : +91-80-42012469 / 43791614 / 29903013

Centrix – 2869 / 1113

<https://www.indiamart.com/annapurnatechnologiesinc/>