



APEXA X

APEXA X inherits innovative APEXA design concept with improved performance of Intel Celeron N97 processor.



POS faithful to the basics of POS

APEXA X



Inheriting the iconic design of APEXA

POSBANK's representative model proven in the industrial field
This is the most familiar and clean POS design that maintains APEXA's concept



Simple dual monitor setup and easy maintenance

DisplayPort mini DP port is available for easy utilization of dual monitors without adjusting CMOS power settings



I/O port improvement (two 9-pin serial DB9 standard)

By providing two DB9 ports, it is easy to connect peripheral devices



Excellent cost-effectiveness

Posbank offers high specification and sophisticated design at a competitive price



Improved performance N97 (3.6Ghz) 8G /128G, Speaker(factory option)

Intel N97, which uses Intel's 12th generation Alder Lake, can perform a variety of powerful functions required in the retail and restaurant industries.

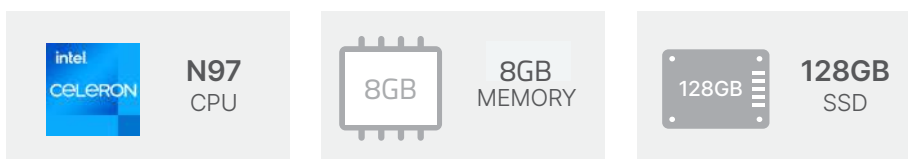

POS CPU performance comparison

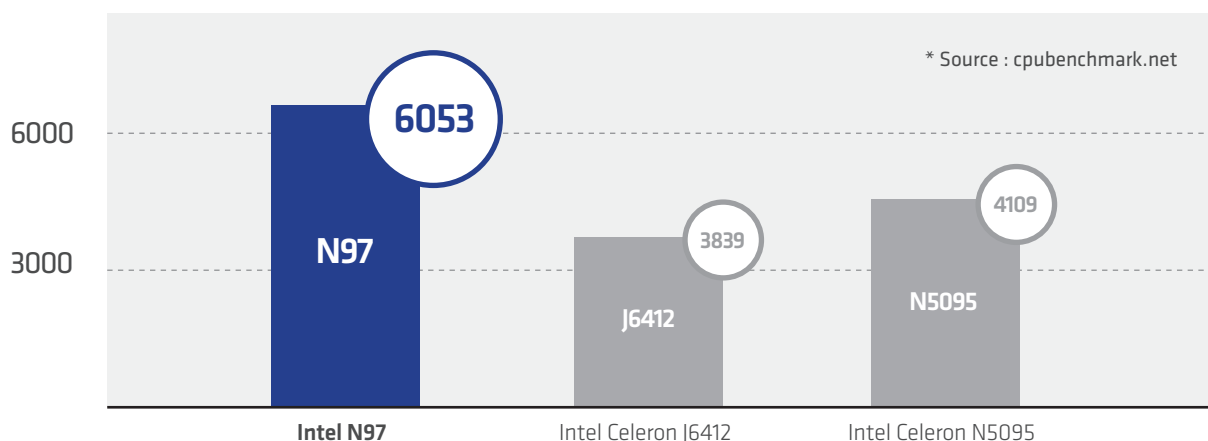

Product features and benefits



Modern and stylish design

- Compact size save countertop space
- Increased store interior design



Bright and clear touch screen

- 15" TFT, LCD, and PCAP touch
- Fast and delicate touch



Spill proof design

- Prevents foreign substances
- Suitable for F&B environments

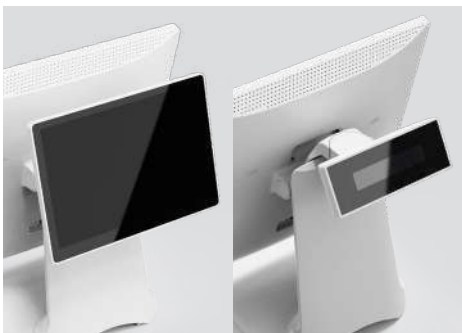

Supports Customer Display

- Customer Display (9.7" / 15" touch options)
- VFD



Supports various options

- MSR card reader, etc
- Wall mount kit



Supports flexible installation methods

- Stand or Wall-Mount Type
- VESA mount compatible (optional)

Interface : I/O Port



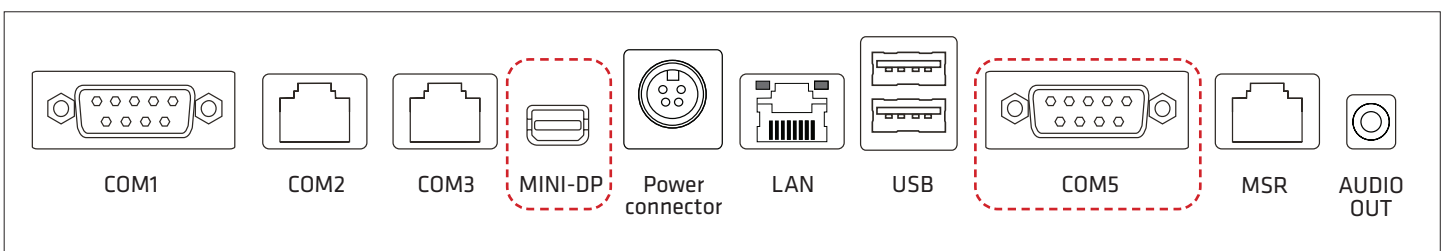

Top I/O port

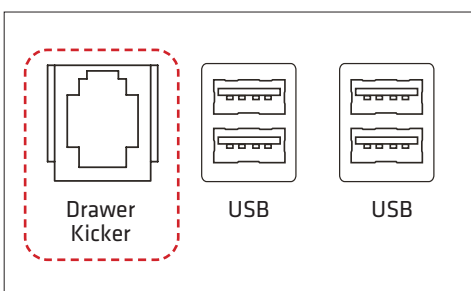

Bottom I/O port

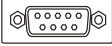
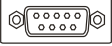

I/O port comparison ※ Refer to the I/O port difference between existing APEXA G and APEXA X

APEXA X		APEXA G	
	MINI-DP <ul style="list-style-type: none"> • 2nd Display connection port • No need for separate CMOS settings 		RJ-11 <ul style="list-style-type: none"> • Only TX/RX, 12V Power Output, Reserved for CDP
	COM5 (DB9) <ul style="list-style-type: none"> • Standard 9-pin serial port • Easy to connect peripheral devices • No power settings needed 		VGA <ul style="list-style-type: none"> • Graphics support
	Drawer Kicker <ul style="list-style-type: none"> • Standard option 		Drawer Kicker <ul style="list-style-type: none"> • Factory option

Specification

System	
Processor	Intel® Processor N97 6M Cache, up to 3.60 GHz
Chipset	Intel® Alder Lake-N
Memory	8GB Standard, DDR4 3200 MT/s, Socket 1x SODIMM (Max. 16GB)
Storage	SATA 3 (6Gb/s) 2.5 inch SSD 128GB, Support AHCI (Max. 1TB)
Operating System	Windows 10 IoT LTSC 21H2 onwards
Audio	HD Audio Codec

Display	
Type	15" TFT LCD, LED Backlight
Resolution	1024 x 768
Brightness	350 cd/m ² (typ.)
Touchscreen	Projected Capacitive Touch

Interface	
Display	Displayport (MiniDP/ With Power Output)
USB	6 x External Ports (USB 3.0 X 2 , USB 2.0 X 4)
Serial	5 x External Ports COM1 with 5V/12V power output on the D-sub pin 9 COM2,COM3 RJ-45 pin 8 COM5 D-sub pin 9 COM6 Tx/Rx Only RJ-45 Reserved for MSR
Cash Drawer Port	(RJ-12 6 Pins) x 1
LAN	1 x Gigabit Ethernet (RJ-45)
Audio	1 x Line-out
Power DC-IN	4 Pin DIN Jack
Extension Slot	M.2 2242 for SSD (Factory Option)

Power	
Power Supply	Adapter 12V, 5A (4P DIN)

Physical & Environmental	
Operating Temperature	0°C ~ 60°C at 10% to 90% Humidity
Storage Temperature	-20°C ~ 80°C at 10% to 90% Humidity
Dimensions (W x H x D)	364x333x210 mm, 14.3x13.1x8.2 in
Packing Dimensions (W x H x D)	475x411x196 mm, 18.7x16.2x7.7 in
Net Weight	5,300g, 11.68 lbs
Packing Weight	8,000g, 17.63 lbs
Certification	KC, CE, FCC

Options & Peripherals	
2nd Displays	9.7", 15" LCD Display, 1024 x 768, (Optional Touchscreen)
Wall Mount Kit	VESA-Compatible, 75 x 75 (mm), 100 x 100 (mm)
Speaker	2 x 1W (Factory Option)

* Specifications may change without prior notice

Dimensions

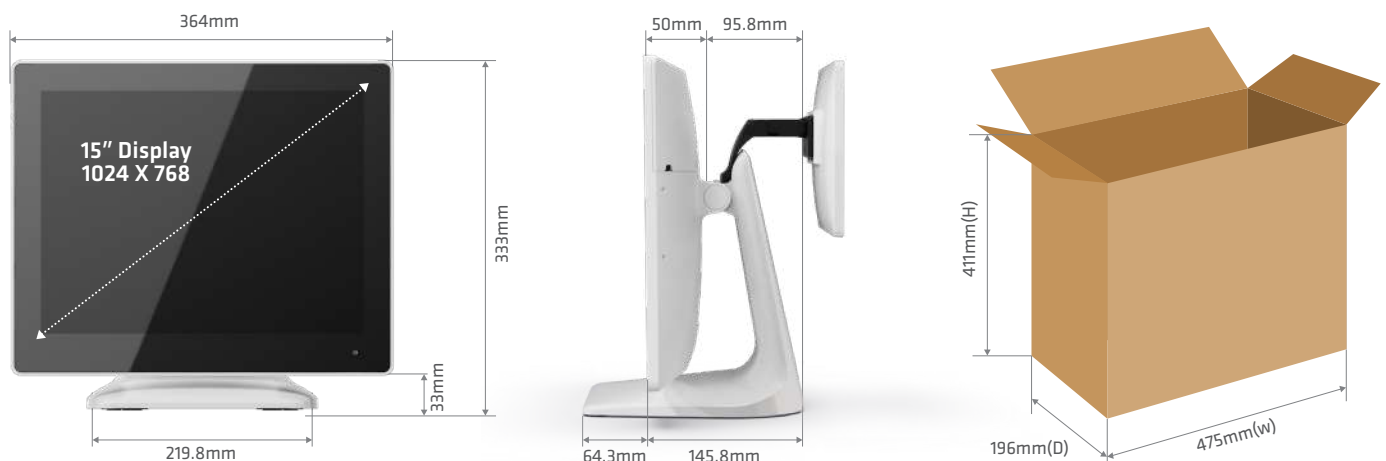

Annapurna Technologies Inc.

☎ : +91 9945003176 | ✉ : yashas@annatechinc.com

📍 : No.48/2,2nd Floor, Opposite Metro Pillar No-82, Rashtriya Vidyalaya Rd,Basavanagudi, Bengaluru, Karnataka 560004